

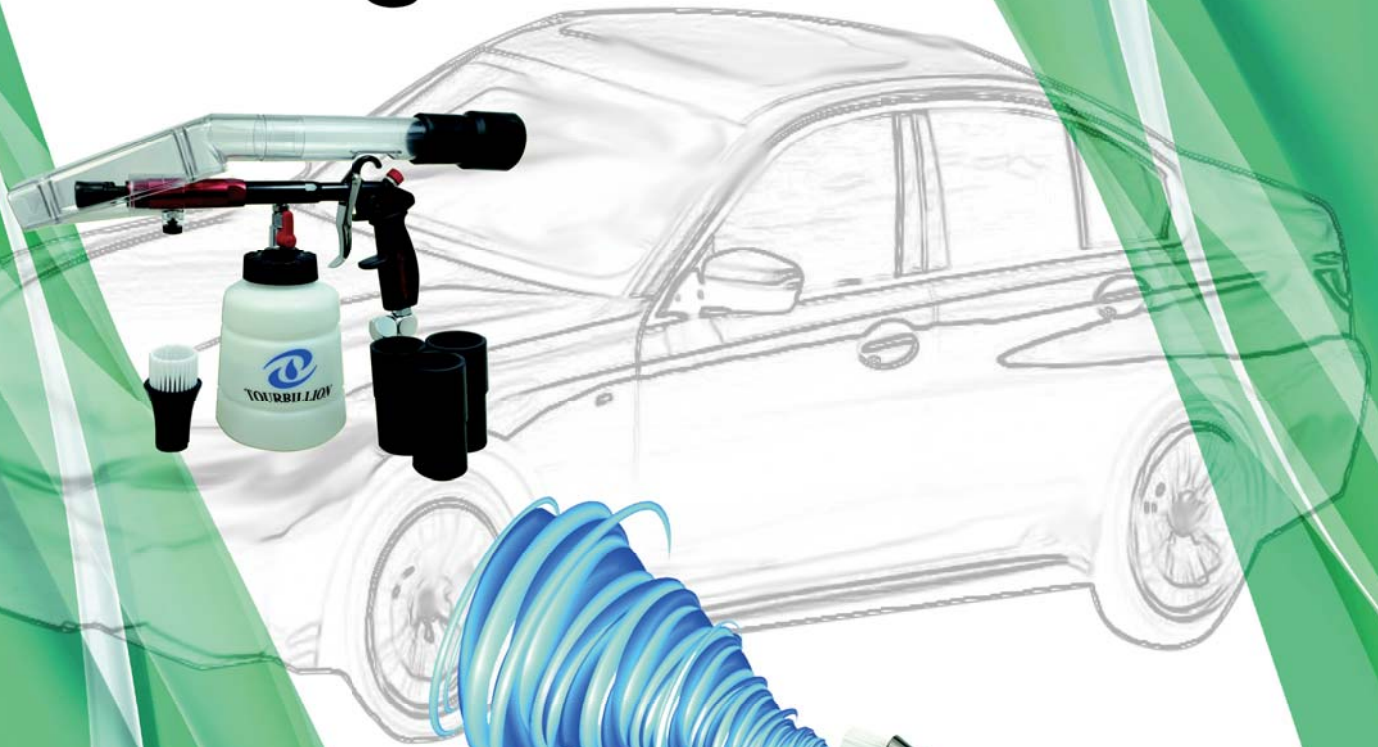

TOURBILLION



TOURBILLION CLEANING GUNS

◇ Whirlwind Tools Co., Ltd. specialized in the excellent experiences and skills of the team members with best technology in car cleaning, we offer complete range of cleaning guns with “patent” for car cleaning application.

◇ **Multi-patent** PATENT

Taiwan, China, U.S.A. , Germany, France

◇ Usage



NEWLY DESIGNED EXTRACTOR

This is a newly developed circular $\text{Ø}70\text{mm}$ extractor set. The product itself has three positions that can be rotated / changed in order to cope with the inconvenience of the small space encountered in actual use. It can be more flexible to avoid the obstacles caused by these spaces to achieve the effect of cleaning / vacuuming. It can also be used on Whirlwind's full series of WT-0100 & WT-0200 & TB-2014 & TB-2020 cleaning gun products.



ACCWT-0100BSR(PC)

▶ Where the dust collection pipe is connected can be rotated 360° .



▶ The front vacuuming port can be rotated 360° .



360°

360°

▶ The body of extractor can be rotated 90° left and right.



90°

NEWLY DESIGNED EXTRACTOR SET

ACCWT-0200BS (PP)
PP Big Size Extractor Set



ACCWT-0200BS (PC)
PC Big Size Extractor Set

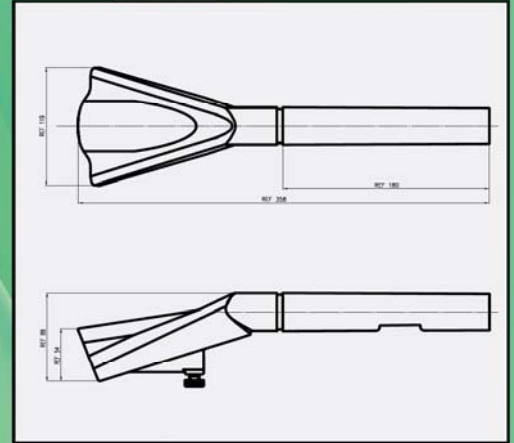

ACTB-2014BSS (PP)
PP Small Size Extractor Set



ACTB-2014BSS (PC)
PC Small Size Extractor Set

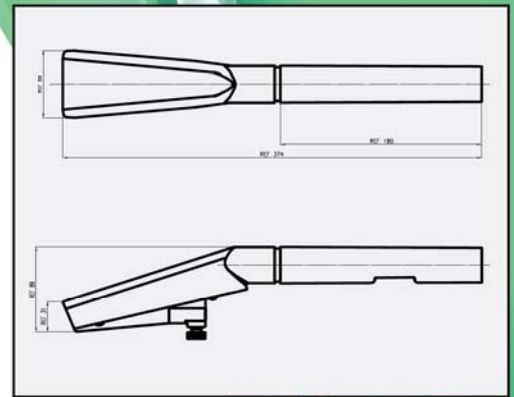

ACCWT-0100BSR (PC)
Newly Designed Extractor Set



ACCWT-0100BSR (PP)
Newly Designed Extractor Set

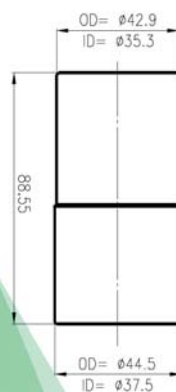
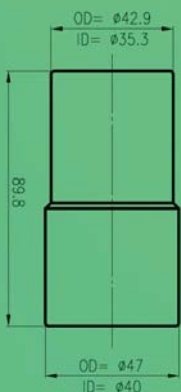
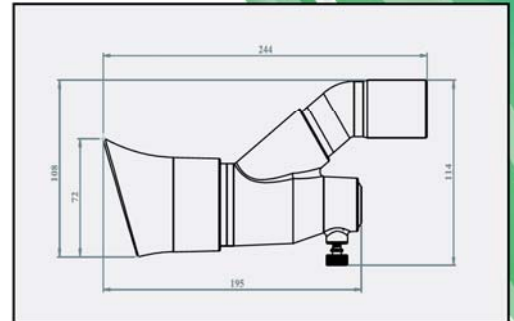

TOURBILLION CLEANING GUNS

TB-2020 ADVANCED BALL CLEANING GUN

- The stream of airflow generated by the high-speed rotation of the BALL is able to generate a frictional force on the inner wall of the Nozzle, make the BALL reduce the speed, and then generate more torque, so that this cleaning gun can enhance the cleaning power.

- 4 special blades are designed on the body of the BALL to generate a stream of airflow when the BALL rotates at high speed, which can prevent foreign objects from entering the Rotatable Set.



- Special Rotatable Set design allows Inner Tube Set will not break for 18 months.

- 4 special blades BALL design can reduce foreign objects entering the Rotatable Set when it uses with large or small Extractor.



TOURBILLION CLEANING GUNS

TB-2020

Advanced Ball Cleaning Gun



TB-2020BS

Advanced Ball Multi-Function
Blow Suction Gun with Big Size
Extractor Set



TB-2020NSBSR

Advanced Ball Blow Gun with
Newly Designed Extractor



TB-2020BSS

Advanced Ball Multi-Function
Blow Suction Gun with Small Size
Extractor Set



TB-2020BSR

Advanced Ball Cleaning Gun
with Newly Designed Extractor



Item No.	TB-2020	TB-2020BS	TB-2020BSS	TB-2020BSR	TB-2020NSBSR
Free Speed	5,500R.P.M.	5,500R.P.M.	5,500R.P.M.	5,500R.P.M.	5,500R.P.M.
Air Inlet	1/4"	1/4"	1/4"	1/4"	1/4"
L*W*H (mm)	330*120*240	360*120*275	360*70*275	330*120*275	290*70*210
Suggested Air Pressure	90Psi	90Psi	90Psi	90Psi	90Psi
Net Weight	0.7Kg	1.2Kg	1.1Kg	1.3Kg	0.9Kg
Average Air Consumption	9CFM	9CFM	9CFM	9CFM	9CFM
Cup	1L	1L	1L	*	*
Declaed Vibration Value, Ahd (m/s ²)	1.1	1.1	1.1	*	*
Uncertainty, K (m/s ²)	0.6	0.55	0.55	*	*
A-Weighted Soudb Pressure Leavel at Workstation in dB (A)	98.9	98.7	101.4	*	*
A-Weighted Soudb Pressure Leavel at Workstation in dB (A) (LPW)	96.3	96.9	99.3	*	*
A-Weighted Soudb Pressure Leavel at Workstation in dB (A) (LPC)	107.3	107.9	110.3	*	*
C-Weighted Soudb Pressure Leavel at Workstation in dB (A) (LPC)	114.2	114.1	114.9	*	*

TOURBILLION CLEANING GUNS

TB-2020N
Advanced Ball Blow Gun



TB-2020NS
Advanced Ball Mini Blow Gun



TB-2020NHBS
Pistol Type Blow Suction Gun with Small Size Extractor Set



TB-2020NHBS
Pistol Type Blow Suction Gun with Big Size Extractor Set



TB-2020NBS
Straight Type Blow Suction Gun with Big Size Extractor Set



TB-2020NBSS
Straight Type Blow Suction Gun with Small Size Extractor Set



TB-2020SBS
Straight Type Blow Suction Gun with Big Size Extractor Set & Transparent Hose 5M



TB-2020SBSS
Straight Type Blow Suction Gun with Small Size Extractor Set & Transparent Hose 5M



Item No.	TB-2020N	TB-2020NS	TB-2020NHBS	TB-2020NHBS	TB-2020NBS	TB-2020NBSS	TB-2020SBS TB-2020SBSS
Free Speed	5,500 R.P.M.	5,500R.P.M.	5,500R.P.M.	5,500R.P.M.	5,500R.P.M.	5,500R.P.M.	5,500R.P.M.
Air Inlet	1/4"	1/4"	1/4"	1/4"	1/4"	1/4"	1/4"
L*W*H (mm)	330*47*160	280*47*160	330*120*210	390*58*100	330*120*210	370*70*95	360*120 (70) * 130
Suggested Air Pressure	90Psi	90Psi	90Psi	90Psi	90Psi	90Psi	90Psi
Net Weight	0.5Kg	0.4Kg	0.65Kg	0.5Kg	0.75Kg	0.8Kg	1.05 / 0.95Kg
Average Air Consumption	9CFM	9CFM	9CFM	9CFM	9CFM	9CFM	9CFM
I.D. / O.D.	*	*	*	*	*	*	5*8mm
Hose	*	*	*	*	*	*	5M
Declared Vibration Value, Ahd (m/s ²)	1.52	1.42	*	*	*	*	*
Uncertainty, K (m/s ²)	0.65	0.64	*	*	*	*	*
A-Weighted sound pressure level at workstation in dB(A)(LPA)	97.0	98.7	*	*	*	*	*
A-Weighted sound pressure level at workstation in dB(A)	94.4	95.9	*	*	*	*	*
A-Weighted sound pressure level at workstation in dB(A)(LPW)	105.4	106.9	*	*	*	*	*
C-Weighted sound pressure level at workstation in dB(A)(LPC)	110.7	111.4	*	*	*	*	*

TOURBILLION CLEANING GUNS

◆ Rotatable Tube Set

WT-0100

Classic Cleaning Gun

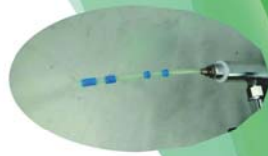

WT-0100S

Classic Cleaning Gun
with Stainless Steel Nozzle



WT-0100SBSR

Classic Cleaning Gun with Stainless Steel
Nozzle & Newly Designed Extractor Set



WT-0100SNSBSR

Classic Blow Gun with Stainless Steel
Nozzle & Newly Designed Extractor Set



WT-0100US

Classic Cleaning Gun with Nozzle Brush



Item No.	WT-0100	WT-0100S	WT-0100SBSR	WT-0100SNSBSR	WT-0100US
Free Speed	3,000R.P.M.	3,000R.P.M.	3,000R.P.M.	3,000R.P.M.	3,000R.P.M.
Air Inlet	1/4"	1/4"	1/4"	1/4"	1/4"
L*W*H (mm)	305*120*240	305*120*240	330*120*275	290*70*210	330*120*240
Suggested Air Pressure	90Psi	90Psi	90Psi	90Psi	90Psi
Net Weight	0.61Kg	0.61Kg	1.2Kg	0.8Kg	0.61Kg
Average Air Consumption	6CFM	6CFM	6CFM	6CFM	6CFM
Declared Vibration Value, Ahd (m/s ²)	0.41	0.41	*	*	0.41
Uncertainty, K (m/s ²)	0.54	0.54	*	*	0.54
A-Weighted sound pressure level at workstation in dB (A) (LPA)	84.3	84.3	*	*	84.3
A-Weighted sound pressure level at workstation in dB (A) (LPW)	95.3	95.3	*	*	95.3
C-Weighted sound pressure level at workstation in dB (A) (LPC)	89.3	89.3	*	*	89.3

TOURBILLION CLEANING GUNS

WT-0100NS/SNS

Classic Mini Blow Gun / Classic Mini Blow Gun with Stainless Steel Nozzle



WT-0100N/SN

Classic Blow Gun / Classic Blow Gun with Stainless Steel Nozzle



WT-0100USD

Professional Cleaning Gun with Nozzle Brush



Item No.	WT-0100NS WT-0100SNS	WT-0100N WT-0100SN	WT-0100USD
Free Speed	3,000R.P.M.	3,000R.P.M.	3,600R.P.M.
Air Inlet	1/4"	1/4"	1/4"
L*W*H (mm)	305*43*160	305*43*160	305*50*50
Suggested Air Pressure	90Psi	90Psi	90Psi
Net Weight	0.4Kg	0.4Kg	0.62Kg
Average Air Consumption	6CFM	6CFM	6CFM
Declared Vibration Value, Ahd (m/s ²)	2.99	2.99	*
Uncertainty, K (m/s ²)	0.79	0.79	*
A-Weighted sound pressure level at workstation in dB (A) (LPA)	93.1	93.1	*
A-Weighted sound pressure level at workstation in dB (A) (LPW)	104.1	104.1	*
C-Weighted sound pressure level at workstation in dB (A) (LPC)	98.3	98.3	*

Foam Generating

WT-0300

Foam Gun



◆ Apparatus



Item No.	WT-0300(1L)
Air Inlet	1/4"
L*W*H (mm)	295*120*260
Suggested Air Pressure	90Psi
Net Weight	0.8Kg
Average Air Consumption	13 CFM
Cup	1L
Double Hose	*



AIA-0001
360° X 360°



AIA-0003
360° X 110°



AIA-0002
360° X 35°

Item No.	AIA-0001	AIA-0002	AIA-0003
Size	PT / PS / NPT	PT / PS / NPT	PT / PS / NPT
Air Inlet	1/4" / 3/8"	1/4" / 3/8"	1/4" / 3/8"

OTHER CLEANING GUNS

WT-0500A
Power Gun



WT-0500
Power Gun

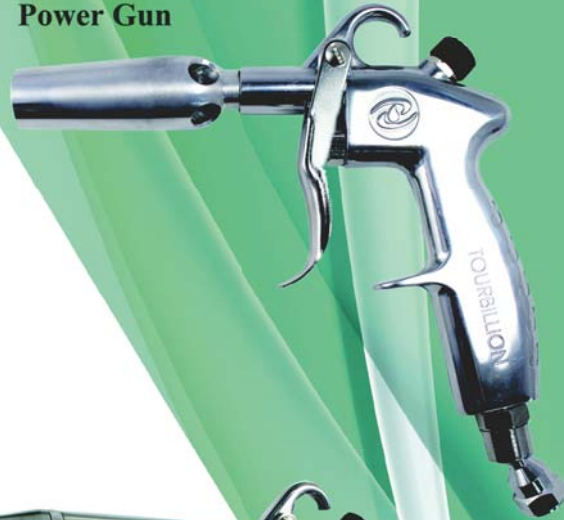

WT-0502
Soda Gun



WT-0501
Dry Flake Gun



Item No.	WT-0500A	WT-0500	WT-0501	WT-0502
Air Inlet	1/4"	1/4"	1/4"	1/4"
L*W*H(mm)	165*25*160	165*25*170	200*65*160	200*120*240
Noise	102.9dB	102.9dB	90.5dB	92.7dB
Suggested Air Pressure	90Psi	90Psi	90Psi	90Psi
Net Weight	0.4Kg	0.4Kg	0.4Kg	0.6Kg

AIR KNIFE BLOW GUN

Different from General Blow Guns Blow Gas Shape is Round and Smaller Area.

Air Knife Blow Guns Blow Gas Shape is Rectangle (flat) Type, Provide a Larger Area of the Gas Blowing Dust.

Its Noise Level is Lower than Traditional Blow Gun.

It is able to Use Different Size of Brush to Increase the Effect of Cleaning.

WT-0510
Air Knife Blow Gun



WT-0510A2
(Soft Brush, Size: Ø 0.2*2cm)



WT-0510B4
(Hard Brush, Size: Ø 0.4*2cm)



WT-0510C4
(Hard Brush, Size: Ø0.4*1cm)



WT-0510S
Air Knife Blow Gun



WT-0510SA2
(Air Knife Blow Gun with Soft Brush Ø0.2*20mm)



WT-0510SB4
(Air Knife Blow Gun with Soft Brush Ø0.2 * 20mm)



WT-0510SC4
(Air Knife Blow Gun with Soft Brush Ø0.4 * 10mm)



Item No.	WT-0510	WT-0510A2	WT-0510B4	WT-0510C4	WT-0510S	WT-0510SA2	WT-0510SB4	WT-0510SC4
Average Air Consumption	15CFM	15CFM	15CFM	15CFM	35CFM	35CFM	35CFM	35CFM
Air Inlet	1/4"	1/4"	1/4"	1/4"	1/4"	1/4"	1/4"	1/4"
L*W*H(mm)	205*24*175	225*24*175	225*24*175	207*24*175	130*46*23	130*46*23	150*46*23	140*46*23
Suggested Air Pressure	90Psi	90Psi	90Psi	90Psi	90Psi	90Psi	90Psi	90Psi
Net Weight	0.3Kg	0.3Kg	0.3Kg	0.3Kg	0.075Kg	0.075Kg	0.075Kg	0.075Kg

CLAY PRODUCT

Clay is Import 100% From Japan, Made In Taiwan

Features:

- * High Quality
- * Clay won't be came down
- * There are 5-7 Layers of Clay on the Products
- * No Any Stick On Car Body After Used
- * No Any Complaints From the End-Users

Yellow-Medium Grade (for Heavy Contaminated Paint & Light Color Paint)

Blue-Fine Grade (For New Car & Dark Color Paint)

ACCP-0601 (Blue 6")

ACCP-0601 (Blue 5")

Clay Pad

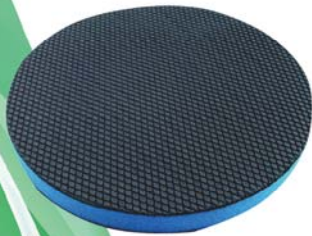

ACCP-0601 (Yellow 6")

ACCP-0601 (Yellow 5")

Clay Pad



ACWM-0601 (Blue)

Wash Mitt



ACCH-30301 (Blue 30*30cm)

ACCP-30302 (Yellow 30*30cm)

Clay Cloth



ACWM-6001 (Yellow)

Wash Mitt

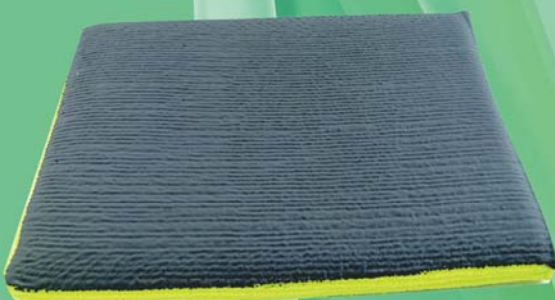

ACCE-0501 (Black, Medium)

ACCE-0502 (Blue, Fine)

Clay Eraser (Sponge)



ULTRA COMPACT ANGLE IMPACT WRENCH

IWA-1882



IWA-2882HR

Loosen these two screws, you can adjust the required angle of head and handle, then tighten.



IWA-1882HR

- The handle can be rotated at an angle of 45°, there are total 8 angles can be chosen for the direction of the trigger. The user is able to use in a narrow space as desired.
- 360° exhaust dust, adjustable at the handle.

PLAM-SHAPED IMPACT WRENCH

IWA-1082RSS

Design come with safety trigger and the trigger can be turn to right or left side, so both hand can be use.



IMPACT WRENCH

IWA-1882

1/2" Ultra Compact Angle Air Impact Wrench



IWA-1882HR

1/2" Ultra Compact Angle Air Impact Wrench
Rotatable Handle



IWA-2882HR

1/2" Ultra Compact Angle Air Impact Wrench
Rotatable Handle



IWA-1082RSS

1/2" Plam-Shaped Air Impact Wrench



Item No.	IWA-1882	IWA-1882HR	IWA-2882HR	IWA-1082RSS
Free Speed	9,000R.P.M	9,000R.P.M	9,000R.P.M	8,500R.P.M
Max.Torque	450 ft-lb / 610 N.m	450 ft-lb / 610 N.m	450 ft-lb / 610 N.m	400 ft-lb / 610 N.m
Clutch type	Jumbo Hammer	Jumbo Hammer	Jumbo Hammer	Jumbo Hammer
Air Inlet	1/4"	1/4"	1/4"	1/4"
Height (from end to end)	260mm	260mm	310mm	115mm
Length (from end to end)	88mm	88mm	88mm	88mm
Anvil	1/2"	1/2"	1/2"	1/2"
Avg.Air Consump.	8.0CFM	8.0CFM	8.0CFM	5.6CFM
Noise Level(sound pressure)	83dB	83dB	83dB	93.8dB
Sug.Air Pressure	90Psi	90Psi	90Psi	90Psi
Net Weight	1.25Kg	1.4 Kg	1.5 Kg	1.15Kg

MINI IMPACT WRENCH

IWA-224230

1/2" Mini Air Impact Wrench



IWA-224231

1/2" Mini Air Impact Wrench



IWA-224232

1/2" Mini Air Impact Wrench



IWA-224234

1/2" Mini Air Impact Wrench



IWA-224235

1/2" Mini Air Impact Wrench



Item No.	IWA-224230	IWA-224231	IWA-224232	IWA-224234	IWA-224235
Free Speed	10,000R.P.M	9,000R.P.M	9,000R.P.M	12,000R.P.M	9,000R.P.M
Max.Torque	500 ft-lb / 678 N.m	500 ft-lb / 678 N.m	450 ft-lb / 610 N.m	750 ft-lb / 1017 N.m	800 ft-lb / 1085 N.m
Clutch type	Jumbo Hammer	Jumbo Hammer	Jumbo Hammer	Twin Hammer	Jumbo Hammer
Air Inlet	1/4"	1/4"	1/4"	1/4"	1/4"
Length (from end to end)	97mm	93mm	88mm	107mm	126mm
Anvil	1/2"	1/2"	1/2"	1/2"	1/2"
Avg.Air Consump.	7CFM	7CFM	7CFM	6CFM	8CFM
Sug.Air Pressure	90Psi	90Psi	90Psi	90Psi	90Psi
Net Weight	1.36Kg	1.3Kg	1.25Kg	1.4Kg	1.8Kg

AIR PENCIL GRINDER

IWM-223000

3mm / 6mm Air Pencil Grinder



IWM-226000

3mm Air Pencil Grinder



Item No.	IWM-223000	IWM-226000
Free Speed	0-30,000 R.P.M	0-60,000 R.P.M
Collet Size	3mm / 6mm	3mm
Mini Hose Size	3/8"	3/8"
Air Inlet	1/4"	1/4"
Length (from end to end)	150mm	150mm
Sug.Air Pressure	90Psi	90Psi
Net Weight	0.38Kg	0.28Kg

IMPACT WRENCH & NEEDLE SCALER

IWA-221191L6

1" Air Impact Wrench



Item No:	IWA-221191L6
Free Speed	7,500 R.P.M
Max.Torque	1800 ft-lb / 2440 N.m
Clutch type	Twin Hammer
Air Inlet	3/8"
Height (from end to end)	115mm
Length (from end to end)	442mm
Anvil	1"
Avg.Air Consump.	21.2CFM
Sug.Air Pressure	90Psi
Net Weight	5.4Kg

HME-223350Y

Composite Air Needle Scaler



Item No.	HME-223350Y
Free Speed	4,300 B.P.M
Needle size and quantity	3mmx180mm, 19pcs
Stroke	38mm
Air Consumption	10 CFM
Noise Power / Pressure	107.1/96.1dB
Air Inlet	1/4"
Length (from end to end)	335mm
Sug.Air Pressure	90Psi
Net Weight	1.8Kg

AIR SANDER

SDC-8360

(Aluminum Body)
3" Random Orbital Sander



SDC-3551 & SDC-3651

(Aluminum Body)
5" & 6" Random Orbital Sander
(No-Vacuun)



SDC-3570 & SDC-3670

(Aluminum Body)
5" & 6" Random Orbital Sander
(Central-Vacuun)



SDC-3561 & SDC-3660

(Aluminum Body)
5" & 6" Random Orbital Sander
(Self-Vacuun)



SDC-1530

3" Palm Random
Orbital Sander



SDC-4530

3" Light Weight Lower
Speed Palm Sander



Item No.	SDC-8630 (Aluminum Body)	SDC-3551 & SDC-3651 (Aluminum Body)
Free Speed	12,000 R.P.M.	12,000 R.P.M.
Pad Size	3" (75mm)	5" (127mm) & 6" (152mm)
Diameter Orbital	5/8" (15mm)	3/16" (8mm)
Noise Level	83dBA	83dBA
Vibration	N/A	N/A
Air Inlet	1/4"	1/4"
Average Air Consumption	530 l/min	530 l/min
Suggested Air Pressure	90Psi	90Psi
Net Weight	0.87Kg	0.95Kg

Item No.	SDC-3570 & SDC-3670 (Aluminum Body)	SDC-3561 & SDC-3660 (Aluminum Body)	SDC-1530	SDC-4530
Free Speed	11,000 R.P.M.	11,000 R.P.M.	12,000 R.P.M.	2,500 R.P.M.
Pad Size	3" (127mm) & 6" (152mm)	5" (127mm) & 6" (152mm)	3" (75mm)	3" (75mm)
Diameter Orbital	3/16" (8mm)	3/16" (8mm)	2.5mm	N/A
Noise Level	83dBA	83dBA	80dBA	80dBA
Vibration	N/A	N/A	N/A	N/A
Air Inlet	1/4"	1/4"	1/4"	1/4"
Average Air Consumption	530 l/min	530 l/min	500 l/min	112 l/min
Suggested Air Pressure	90Psi	90Psi	90Psi	90Psi
Net Weight	0.99Kg	0.99Kg	0.56Kg	0.66Kg

AIR SANDER & POLISHER

SDC-1220
2" Spot Repair Sander



SDC-1331
3" Air composite Random
Orbital Sander



SDC-4230
3" Sander W / Disc
Pad & Sanding Pad



SDC-4322
Air Composite Polisher



SDC-4331
3" Sander W / Disc
Pad & Sanding Pad



SDC-4351
5" High Speed Sander



SDC-1220K
2" Spot Repair Sander Kit



SDC-1331K
3" Air Composite Random
Orbital Sander Kit



SDC-4332K
3" Air Composite Polisher Kit



Item No.	SDC-1220	SDC-1331	SDC-4230	SDC-4322	SDC-4331	SDC-4351
Free Speed	13,000R.P.M.	18,000R.P.M.	15,000R.P.M.	2,200R.P.M.	18,000R.P.M.	18,000R.P.M.
Pad Size	2" (51mm)	3" (75mm)	2" (51mm)	3" (75mm)	3" (75mm)	5" (127mm)
Diameter Orbital	2mm	3mm	N/A	N/A	N/A	N/A
Average Air Consumption	2.6CFM	3.5CFM	3.1CFM	3.5CFM	3.5CFM	3.5CFM
Air Inlet	1/4"	1/4"	1/4"	1/4"	1/4"	1/4"
Suggested Air Pressure	90Psi	90Psi	90Psi	90Psi	90Psi	90Psi
Net Weight	0.5Kg	0.72Kg	0.7Kg	0.77Kg	0.7Kg	1.3Kg

MULTI-COLORED MACHINE POLISHING LAMP ASSEMBLY

LWL-1963L

Patents : United States: US10,753,587 B1
Gerbrauchsmusters Nr:20 2020 101 584
Japan : 3226892
Taiwan Patent Number : M584398
China : ZL 20192 1233053.2



Maximizes correction results whilst increasing efficiency by utilizing the broad spectrum of multi-colored LED light to expose defects on painted surfaces prior-to & whilst polishing. By combining various wave lengths of light & matching them with the specific color of the paint greatly increases the ability to see & refine defects as you polish. This maximizes efficiency as the need to stop & re-inspect after each pass is reduced. Simply Attach the new Multi-colored Lamp Assembly to any Dual Action, Rotary or Forced Action Machine. Polisher & start removing defects on all paint types with more accuracy & precision.

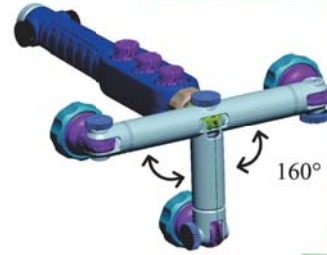
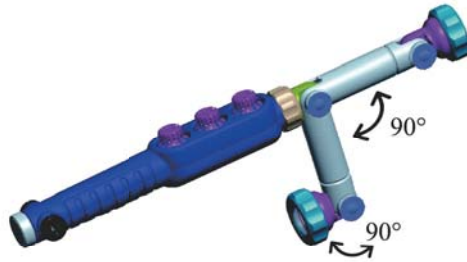

TRI-Color of lights

1. Yellow, 3W, Wave-length : 570~590nm (FR:508-526 THz)
2. Blue, 1W, Wave-length : 476~495nm (FR:606-630 THz)
3. Red, 1W, Wave-length : 620~750nm (FR:400-484 THz)

Suggested Mixed Wave-Length & Paint Color (Rotary Button 1-5 level in Luminance)

Black Paing : Full Yellow

Yellow Paint : 5 Yellow + 3Blue

White Paint : 5Red + 5Yellow

Red Paint : 5 Yellow + 5Blue

Silver Paint : 3Red + 5Yellow + 3Blue

Mix Lighting Images

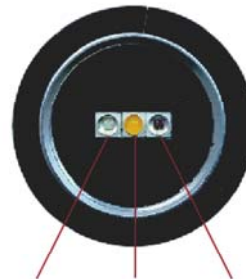

Blue,1W Yellow,3W Red, 1W

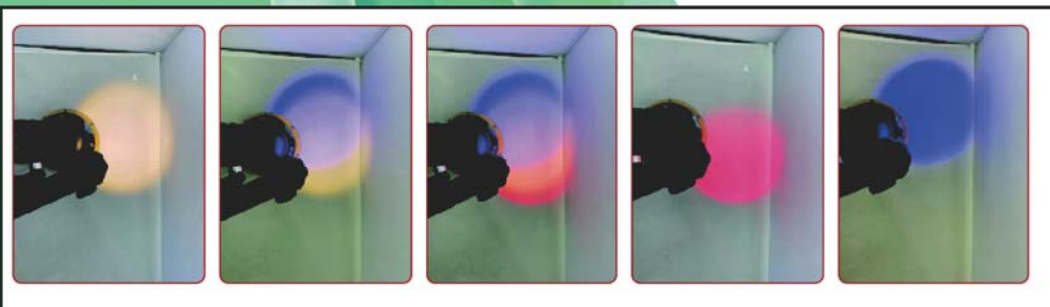

MULTI-FUNCTION TWO-COLOR LED WORKING LIGHT

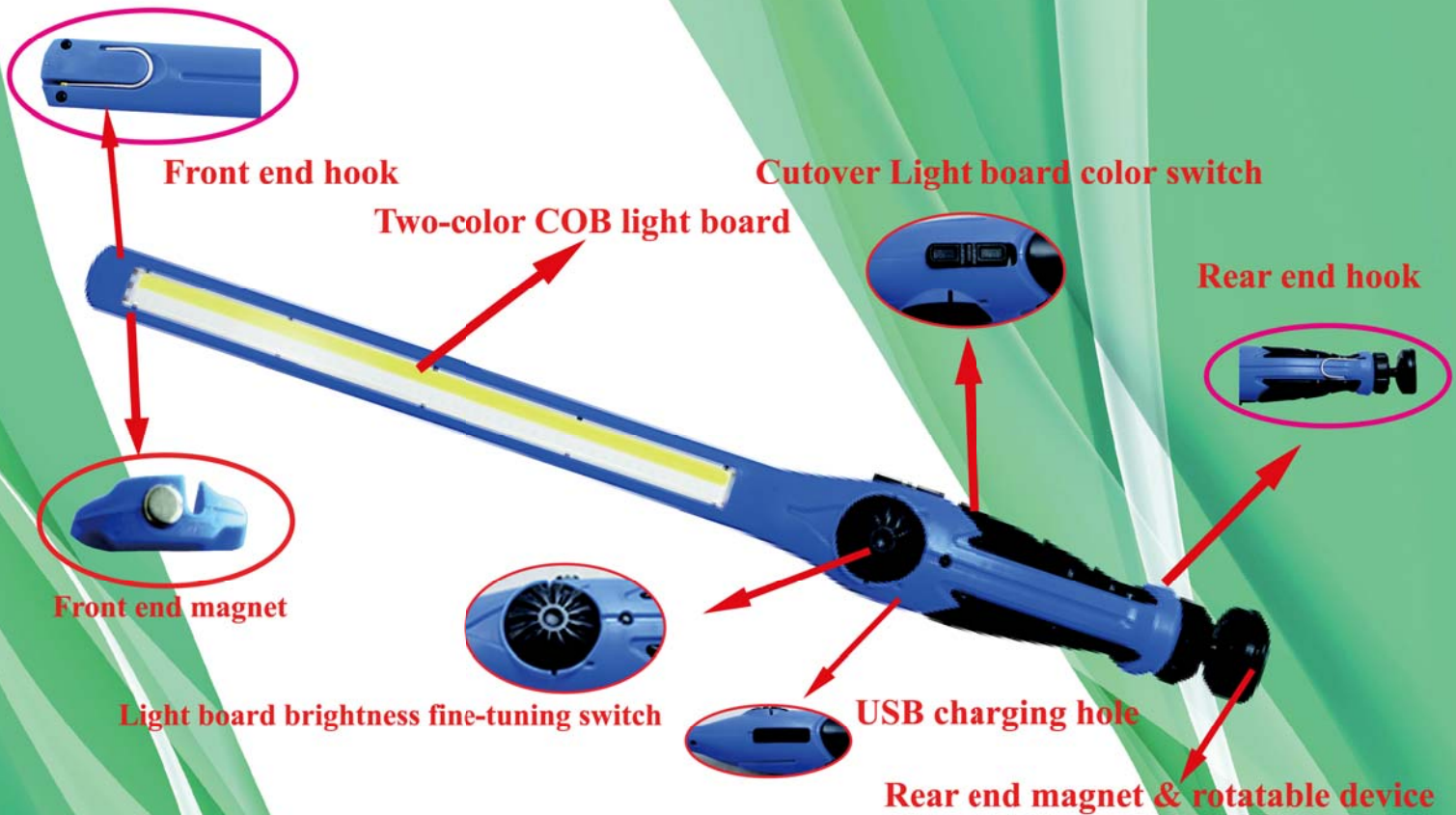

LWL-9880WU, Two-color 10W COB Light Board, One color - white, Another color - UV light

LWL-9880WR, Two-color 10W COB Light Board, One color - white, Another color - red flashing warning light



Engine interior refrigerant detection by UV light. light.



Engine room lighting by white light



Red flashing warning light

Item No	LWL-9880WU	LWL-9880WR
Quantity of COB LED:	10W	10W
Lithium Battery 18650A	3.7V / 3350mAh	3.7V / 3350mAh
Lighting up	3.5H (full light) / 6H(micro light)	3.5H (full light) / 6H(micro light)
Distance illumination of 50cm (8W)	620 Lumen / 1000 Lux (White)	620 Lumen / 1000 Lux (White)
Yellow / White mixed light	*	620 Lumen / 170 Lux (Red)
IP	IP54	IP44
Frequency	50 / 60Hz	50 / 60Hz
L*W*H (mm)	470*50*42	230*30*40
Weight	280g	145g

MULTI-FUNCTION TWO-COLOR AND MONOCHROME LED WORKING G LIGHT



LWL-9880, Monochrome 10W COB light board, monochrome - white



LWL-9880WY, Two-color 20W COB light board, one color - white, Another color - yellow light. Used in the vehicle surface fine lines of irradiation, to determine whether the surface polishing is flat / bright.



Engine room lighting



vehicle surface fine lines of irradiation by LWL-9880WY

Item No:	LWL-9880	LWL-9880WY
Quantity of LED:	20W	10W
Lithium Battery 18650A:	3.7V / 3350mAh	3.7V / 3350mAh
Lighting up:	3.5H (full light) / 6H(micro light)	3.5H (full light) / 6H (micro light)
Distance illumination of 50cm :	880 Lumen / 1300 Lux (White)	620 Lumen / 1000 Lux (White)
Yellow / White mixed light:	*	600 Lumen / 950 Lux (Yellow)
	*	770 Lumen / 1400 Lux
IP:	IP54	IP44
Frequency:	50/60Hz	50/60Hz
L*W*H (mm):	470*50*42	230*30*40
Weight:	280g	145g

COB LED WORKING LIGHT

with Rechargeable Lithium Battery & Magnetic



Left or Right



HOOK

USB

Control Knob

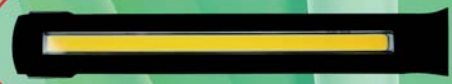

LWL-9470Y
15W COB LED Working Light (yellow)

LWL-9470
15W COB LED Working Light (white)



LWL-5800
5W LED Working Light



LWL-8800
8W COB LED Working Light



LWL-5641
8W COB LED Working Light



Control Knob



USB

Item No.	LWL-9470 / LWL-9470Y	LWL-8800	LWL-5800	LWL-5641
Quantity of LED	15W COB LED	8W COB LED	5W LED	8W COB LED
Lithium Battery	3.7V 2200mAh	3.7V 2200mAh	3.7V 2200mAh	3.7V 2200mAh
Lighting up	2.5H(full light) 6H (micro light)	2.5H(full light) 6H (micro light)	2.5H(full light) 6H (micro light)	2.5H(full light) 6H (micro light)
Distance illumination of 50 cm	935 LUX /458 LUM	450 LUX / 280 LUM	450 LUX /260 LUM	450 LUX / 318 LUM
Frequency	50 / 60 Hz	50 / 60 Hz	50 / 60 Hz	50 /60 Hz
L*W*H (mm)	375*45*35	345*38*33	380*38*33	210*26*28
Weight	200g	226g	230g	127g

8W MULTI-FUNCTION LED WORKING LIGHT

LWL-8740 & LWL-8740UV

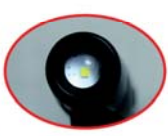

3W white or UV light with adjustable focal length



8W Light source brightness control switch

8W COB light

3W & 8W light control switch

Back hook with magnet



USB charging hole



Bottom magnet with bending device



Use 3W lights for depth lighting



Use 8W light to make large area lighting

Item No	LWL-8740	LWL-8740UV
Quantity of COB LED:	8W	8W
Lithium Battery 18650A	3.7V / 2200mAh	3.7V / 2200mAh
Distance illumination of 50cm (8W)	400 Lumen	400 Lumen
3W Tip Light	White	White
Charger Time	3.5~4.0 hours	3.5~4.0 hours
Active Time	3 hours	3 hours
IP	IP44	IP44
Frequency	50 / 60Hz	50 / 60Hz
L*W*H (mm)	230*30*40	230*30*40
Weight	145g	145g



TOURBILLION

WHIRLWIND TOOLS CO., LTD.

MAIL : info@whirlwindtools.com

WEB : <http://www.whirlwindtools.com>

TEL : +886-2-2692-6399

FAX : +886-2-2694-6867

ADDRESS : No. 12, Lane 351, Fude 1St Road, Xizhi Dist., New Taipei City 22149, Taiwan